

05/18 IL03801021Z

## T0(3)-.../Z/SVB

## T0(3)-.../V/SVB

	a
T0	7.5 mm (0.3")
T3	9.5 mm (0.37")
UV-T0	9 mm (0.35")

	T0...	T3...
	1 x 0.75 - 1.5 mm <sup>2</sup>	1 x 0.75 - 4.0 mm <sup>2</sup>
	2 x 0.75 - 1.5 mm <sup>2</sup>	2 x 0.75 - 4.0 mm <sup>2</sup>
	1 x 1.0 - 2.5 mm <sup>2</sup>	1 x 1.0 - 6.0 mm <sup>2</sup>
	2 x 1.0 - 2.5 mm <sup>2</sup>	2 x 1.0 - 6.0 mm <sup>2</sup>
tightening torque	<b>1 Nm</b> (8.85 lb-in)	<b>1.6 Nm</b> (14.16 lb-in)
	AWG18 - AWG14	AWG14 - AWG10
		<b>2 Nm</b> (17.7 lb-in)



### T0(3).../Z

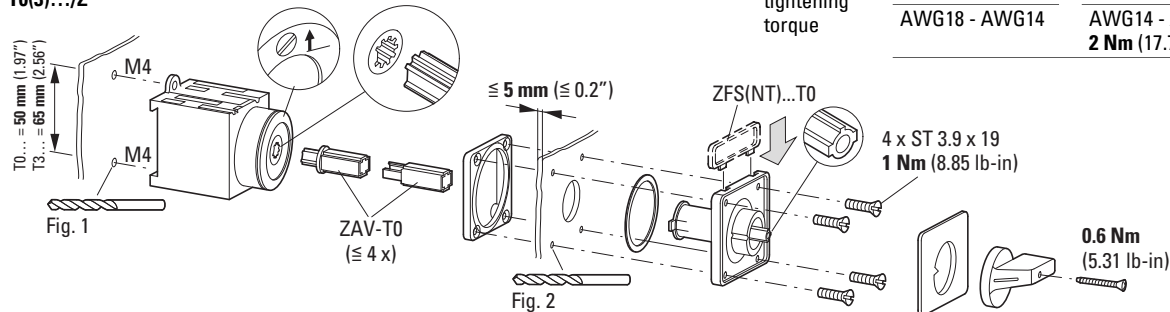

### T0(3).../Z/SVB

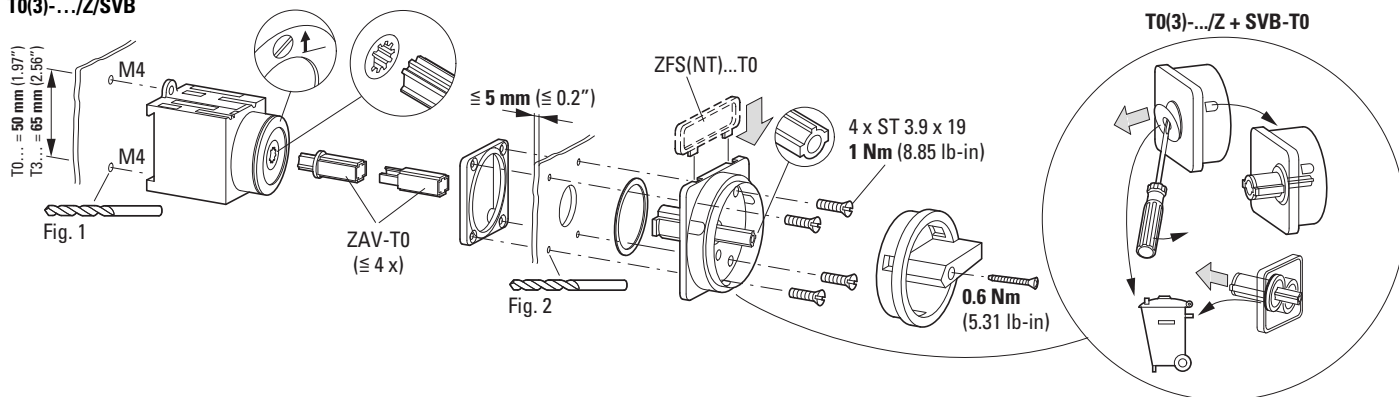

### T0(3).../V/SVB

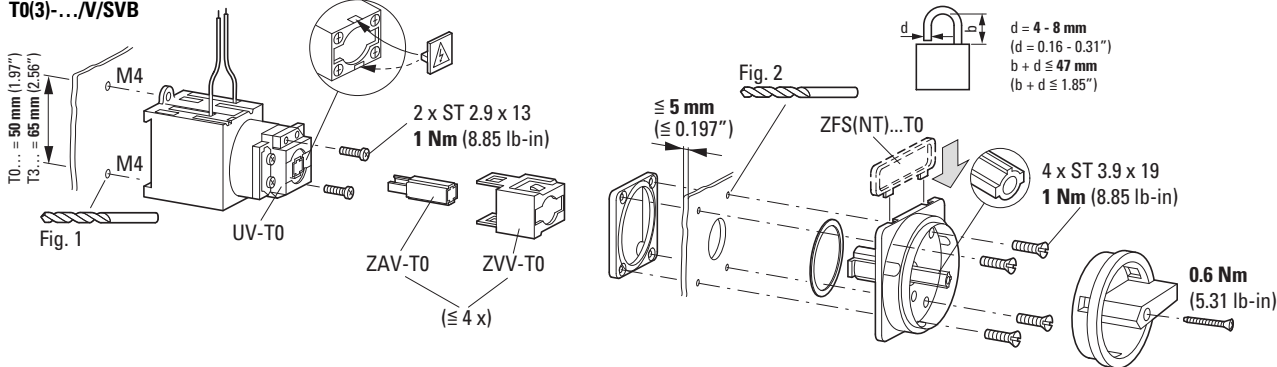

**UL/CSA:**  
Suitable For Use As Motor Branch Circuit Disconnecting Means With Suffix SVB.  
Break All Lines.  
Short Circuit Withstand  
10 kA RMS SYM 600 V AC  
Max Fuse T0... - 20 A Class J  
T3... - 40 A Class J  
Standard Short Circuit  
5 kA RMS SYM 600 V AC  
Max Fuse T0... - 50 A  
T3... - 40 A  
Max Cir. Bkr. T0... - 50 A  
T3... - 125 A  
Switch or enclosure must be padlockable if used as a Motor Branch Circuit Disconnecter means.

→ ± 1 : 1

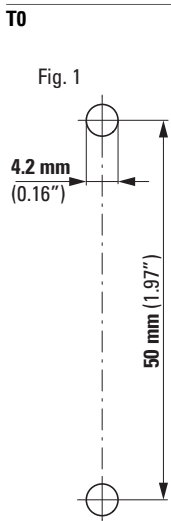

→ ± 1 : 1



→ ± 1 : 1

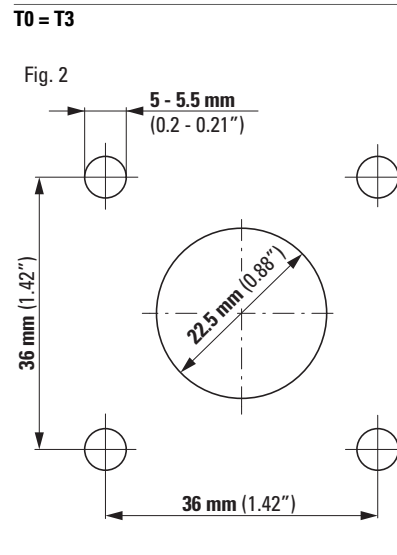

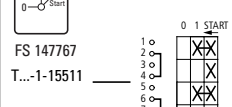
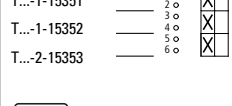
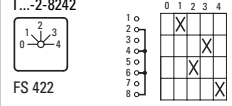
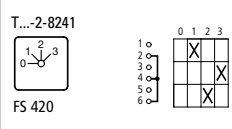
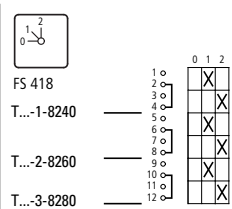
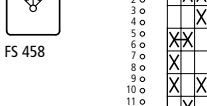
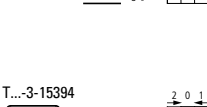
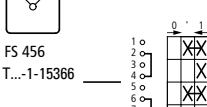
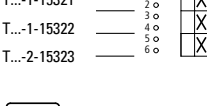
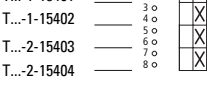
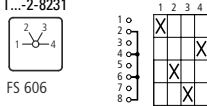
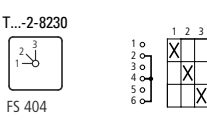
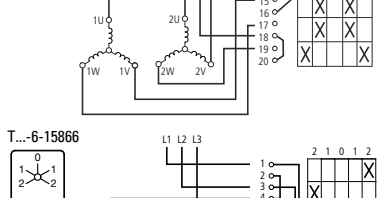
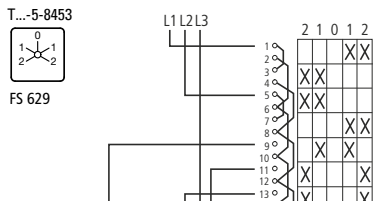
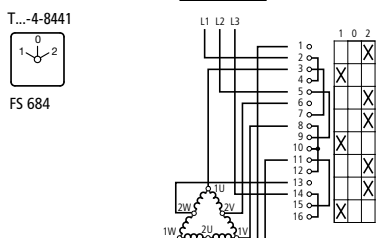
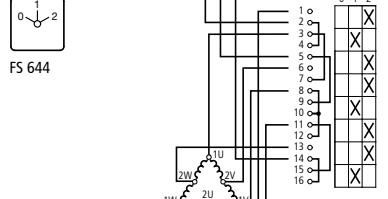
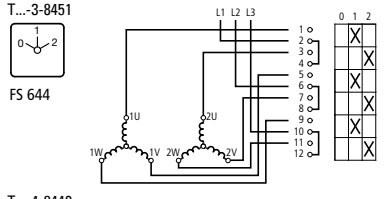
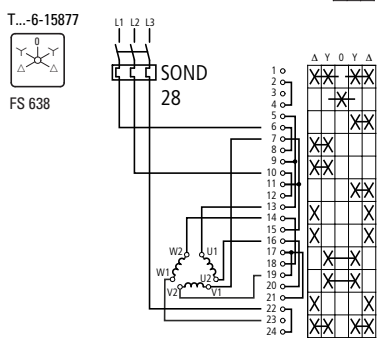
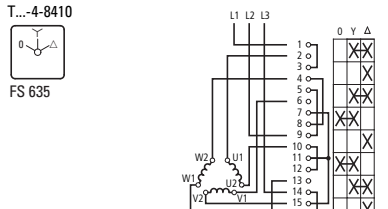
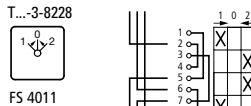
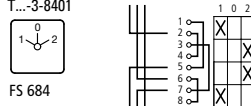
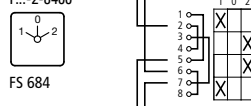
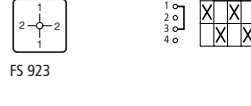
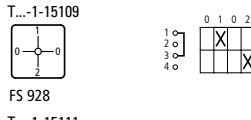
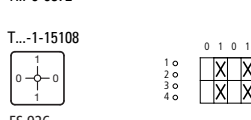
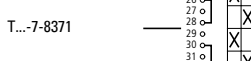
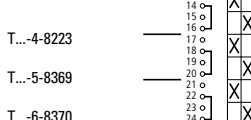
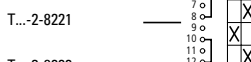
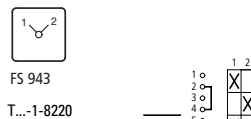
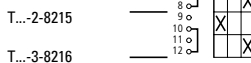
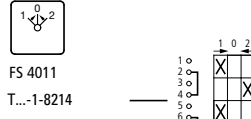
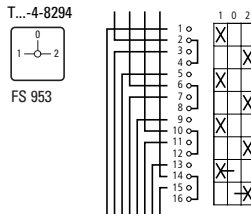
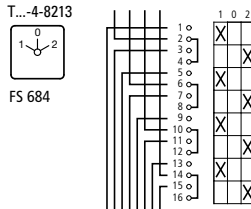
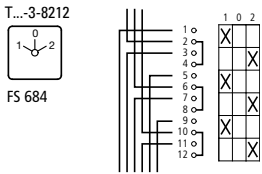
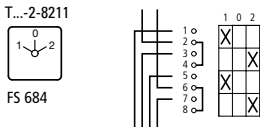
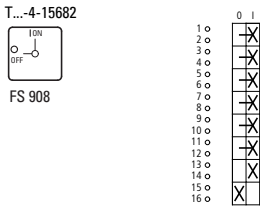
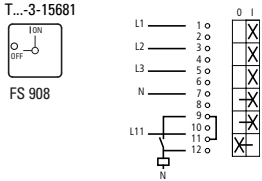
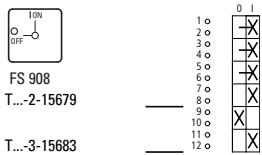
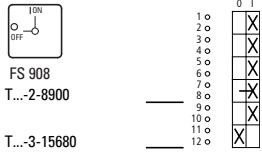
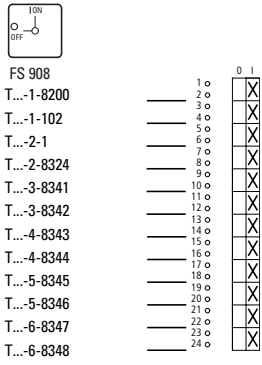

05/18 IL03801021Z